

Track End Feed Wiring Guide

VIDEO LINKS

Wire Power to
End Feed



[Link to Video](#)

Wire DMX to
End Feed via XLR5

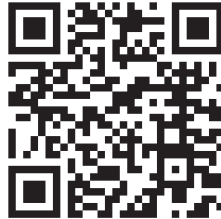

[Link to Video](#)

Wire DMX to
End Feed via RJ45



[Link to Video](#)

Wire DMX to
End Feed via TRRS



[Link to Video](#)

STEP-BY-STEP INSTRUCTIONS

Please refer to the listed QR Code/Links for detailed step-by-step instructions for the wiring cable per installation requirements. Contact design@kessil.com for more information.

READ AND SAVE ALL INSTRUCTIONS

- Disconnect electrical power before adding to or changing the configuration of the track.
- Do not install this track in damp or wet locations (IP20 , 45°C max).
- Do not install any part of a track system less 5 ft. above the floor.
- Check with a qualified electrician prior to any installation.
- Do not attempt to energize anything other than lighting track fixtures on the track.
- In order to reduce the risk of fire and electrical shock, do not attempt to connect power tools, extension cords, appliances and the like to the track.
- Do not slide light fixtures along track when relocating. Always remove fixture/adaptor from track.
- Before reinstalling in new location, make sure to properly secured adapter back in track.

05262022A

Wire Power to End Feed

Each End Feed component has two (2) sets of 20A-max conductors for two (2) individual power circuits.

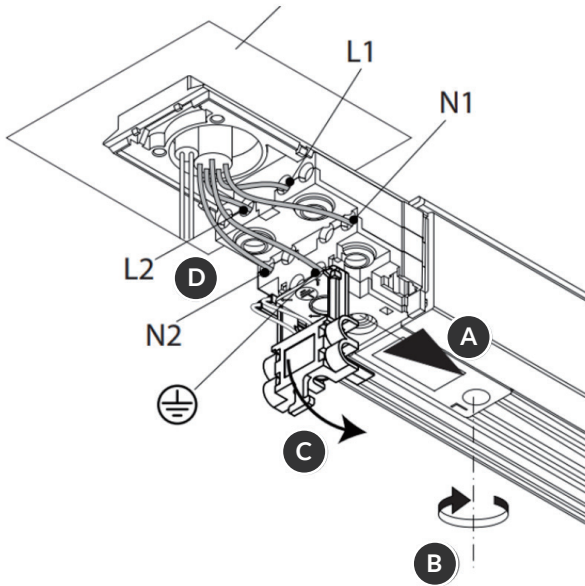

Line drawing of power splicing on End Feed

Legend

A 233 Series, 2 Circuit 120V Track

B Securing screw for end feed component

C DMX/Data conductor entry

D Power conductor entry for Circuit 1 and Circuit 2



[Link to Video](#)

End feed Component with pin-outs

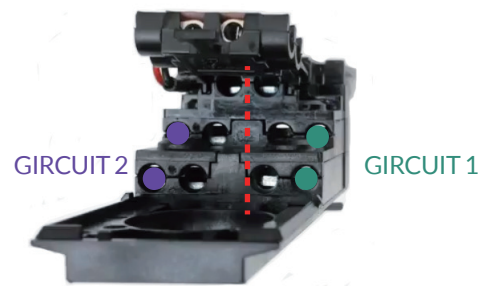
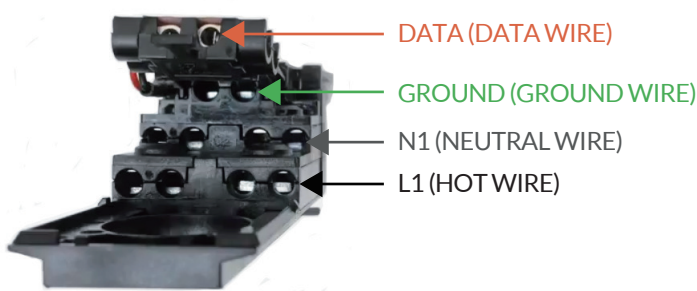

EACH CIRCUIT CAN HANDLE
A **MAXIMUM** CURRENT OF
20 AMPS

Wire DMX to End Feed

DMX signal requires 2 signal carriers and the polarity of the DMX conductors are labelled on the sticker located on the end feed component.





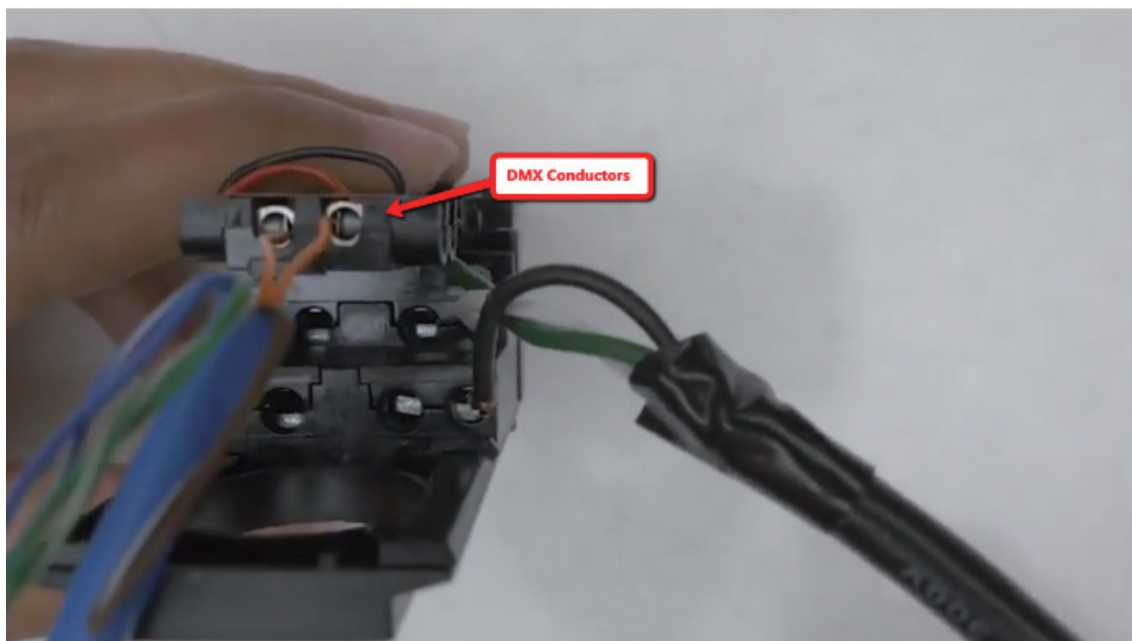

DMX Polarity Label Sticker



DMX Conductors wired to End Feed

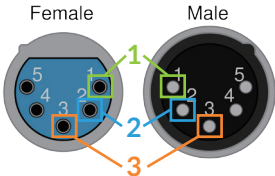
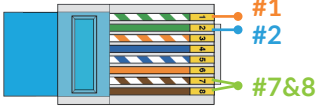
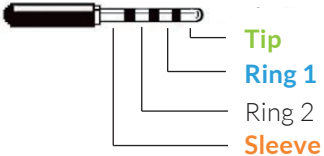

Standard DMX Cabling and Polarity

		XLR5	RJ45	TRRS
Connector				
Description		DMX lighting standard	Architectural, corporate, and fixed installations	Fiilex DMX Controller, P360 Pro and P360 Pro Plus.
Connector Pin-out				
Signal	Ground	1	7, 8	Tip
	Data -	2	2	Ring1 (closest to tip)
	Data +	3	1	Sleeve
Video Guide		 Link to Video	 Link to Video	 Link to Video